

Irontech

stiff 33.

smart cranes

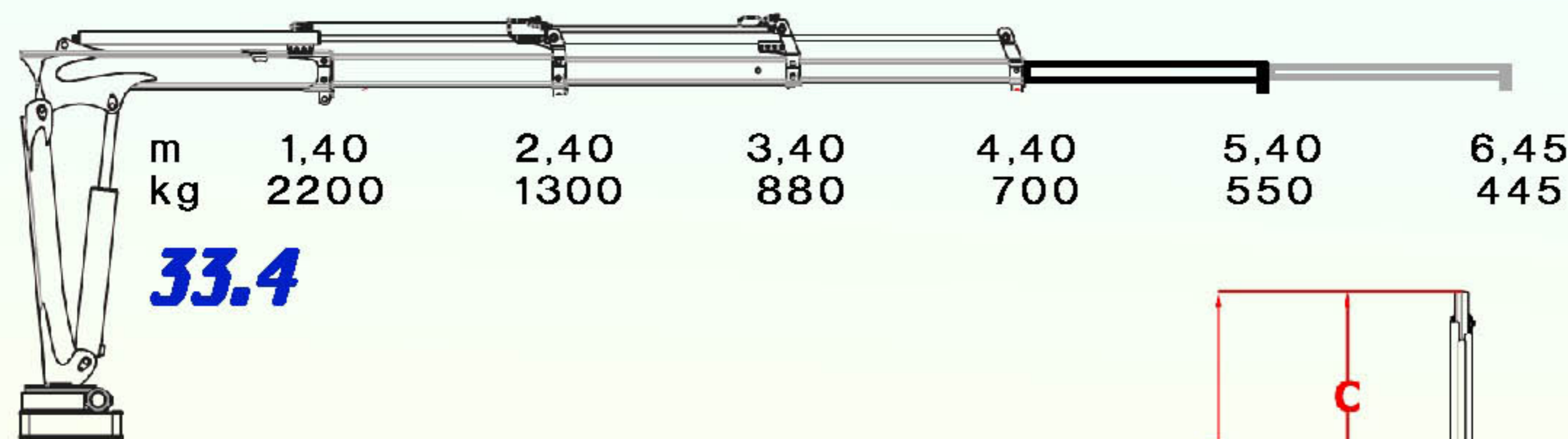
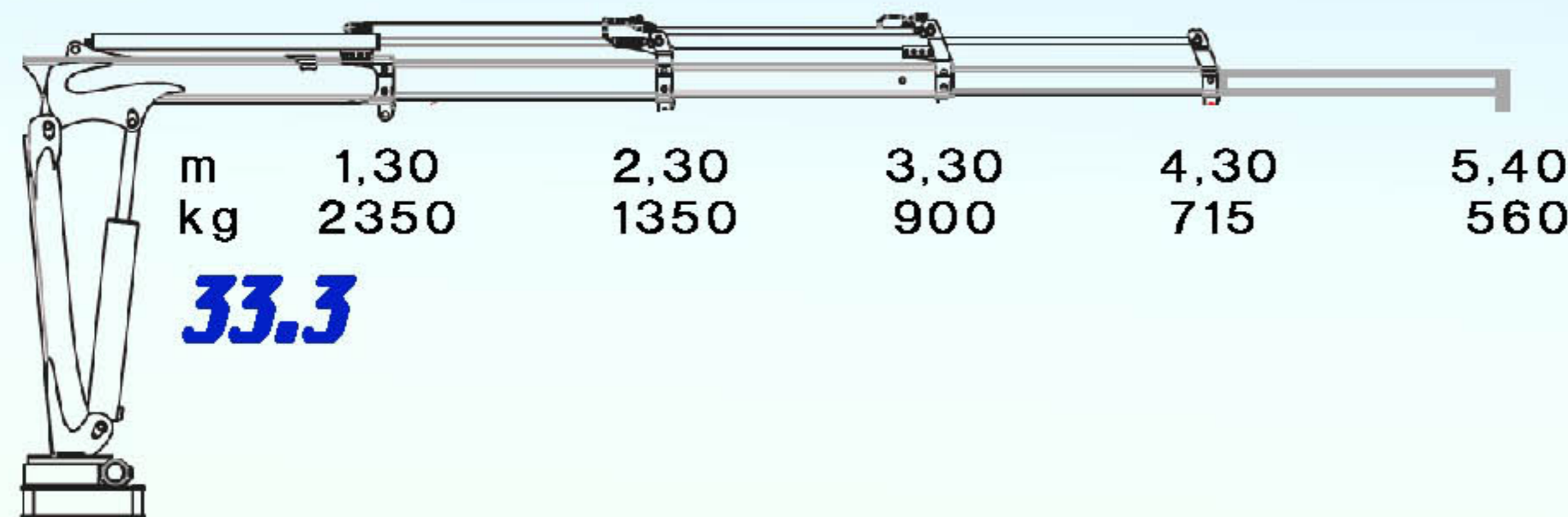
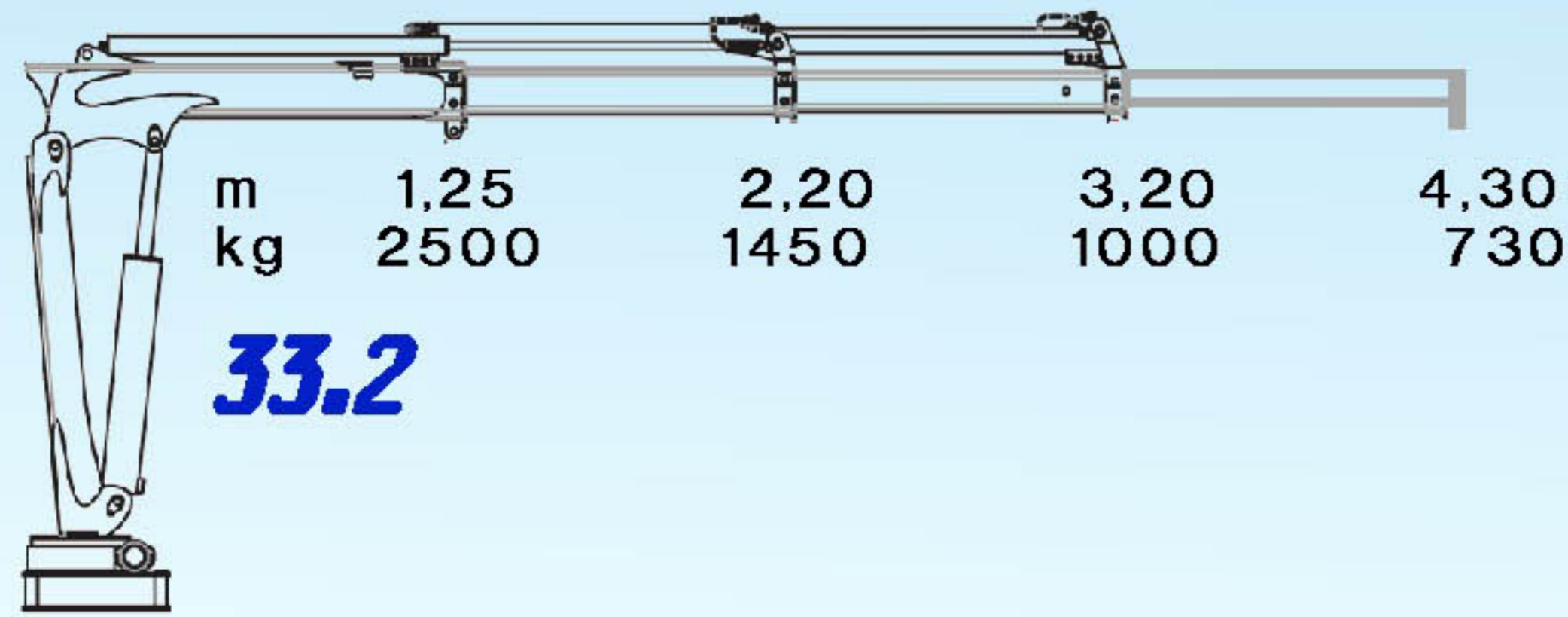

COPS 3 SPS inside

0170602

Technische Daten		
Fiche Technique		
Caratteristiche Tecniche		
Kranbau- Norm projecté selon les normes norma tecnica di progetto	DIN	15018 H1B3
Hubmoment capacité de levage capacità di sollevamento	daNm	3300
Schwenkbereich angle de rotation angolo di rotazione	°	360
Schwenkmoment couple de rotation coppia di rotazione	daNm	450
Betriebsdruck pression de travail pressione die esercizio	bar	230
Fördermenge debit au distributeur portata max al distributore	l/min	10-15
Gewicht Basisausführung poid de la grue peso gru base	A2 A3 A4	320 335 355
Gewicht Abstützung poids stabilisateur peso stabilizator	kg	80-150

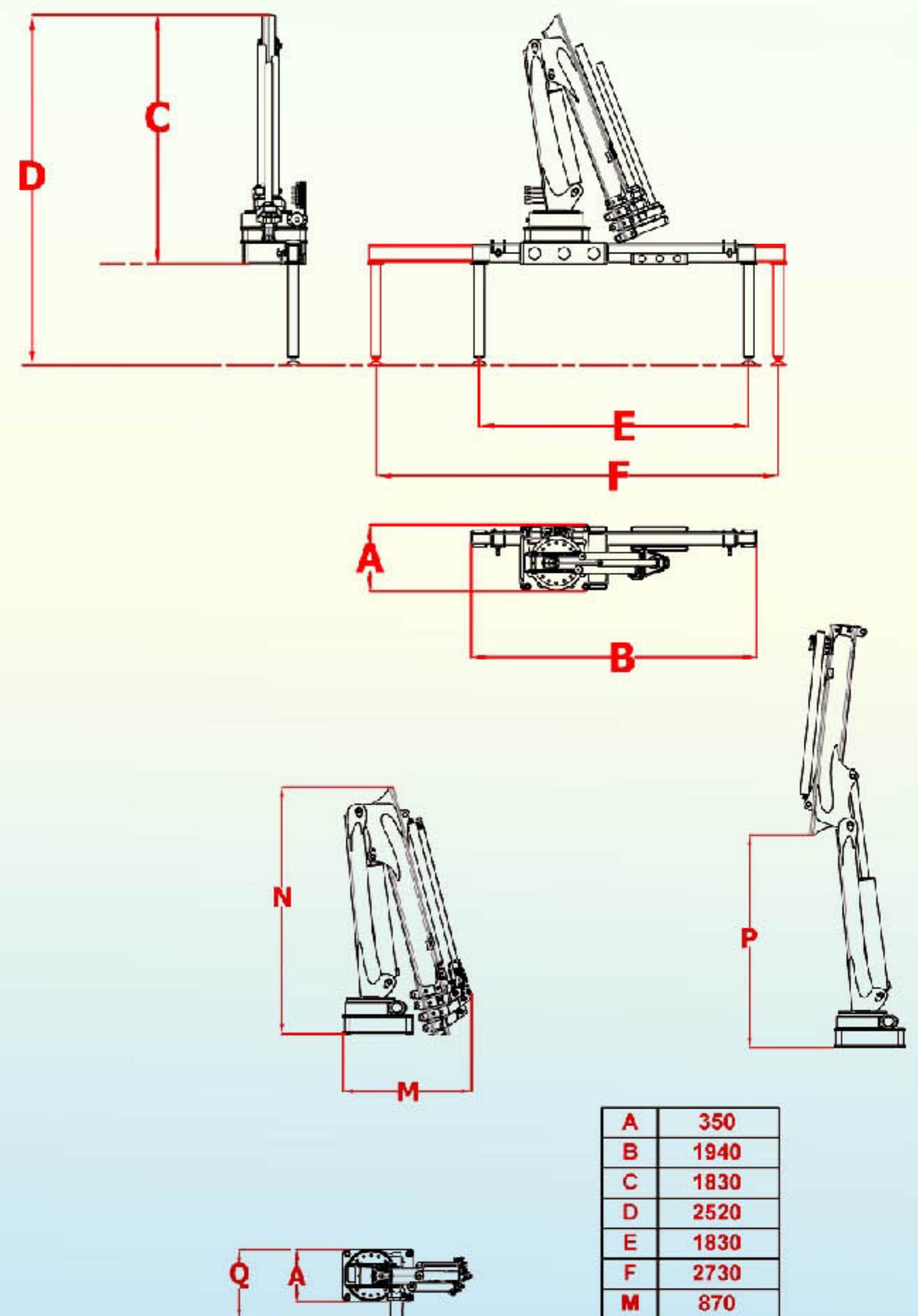

A	350
B	1940
C	1830
D	2520
E	1830
F	2730
M	870
N	1680
P	1430
Q	1430

KRANTECH.CH