

Zweischalengreifer für Bagger mit Industrie- Drehmotor

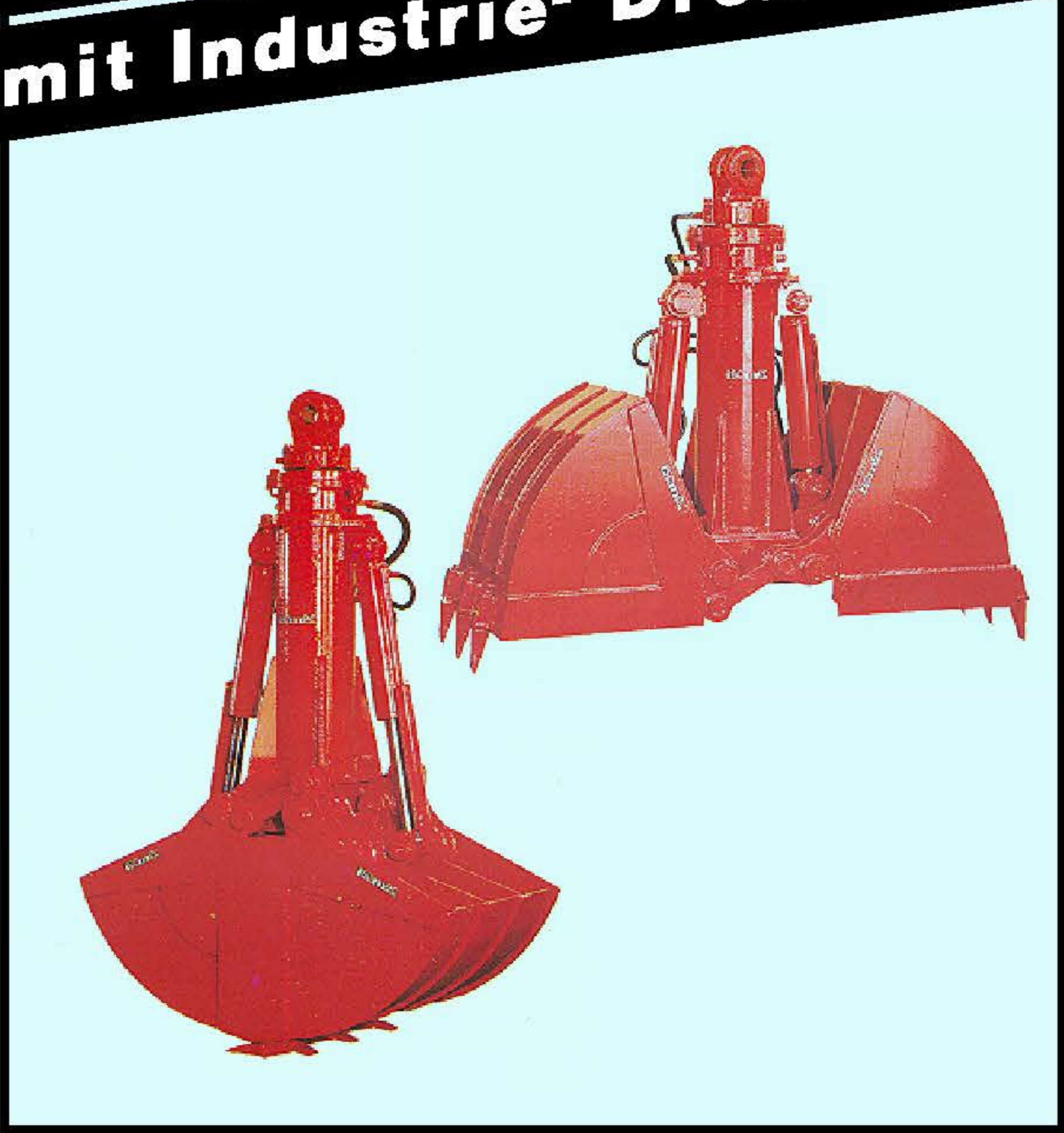

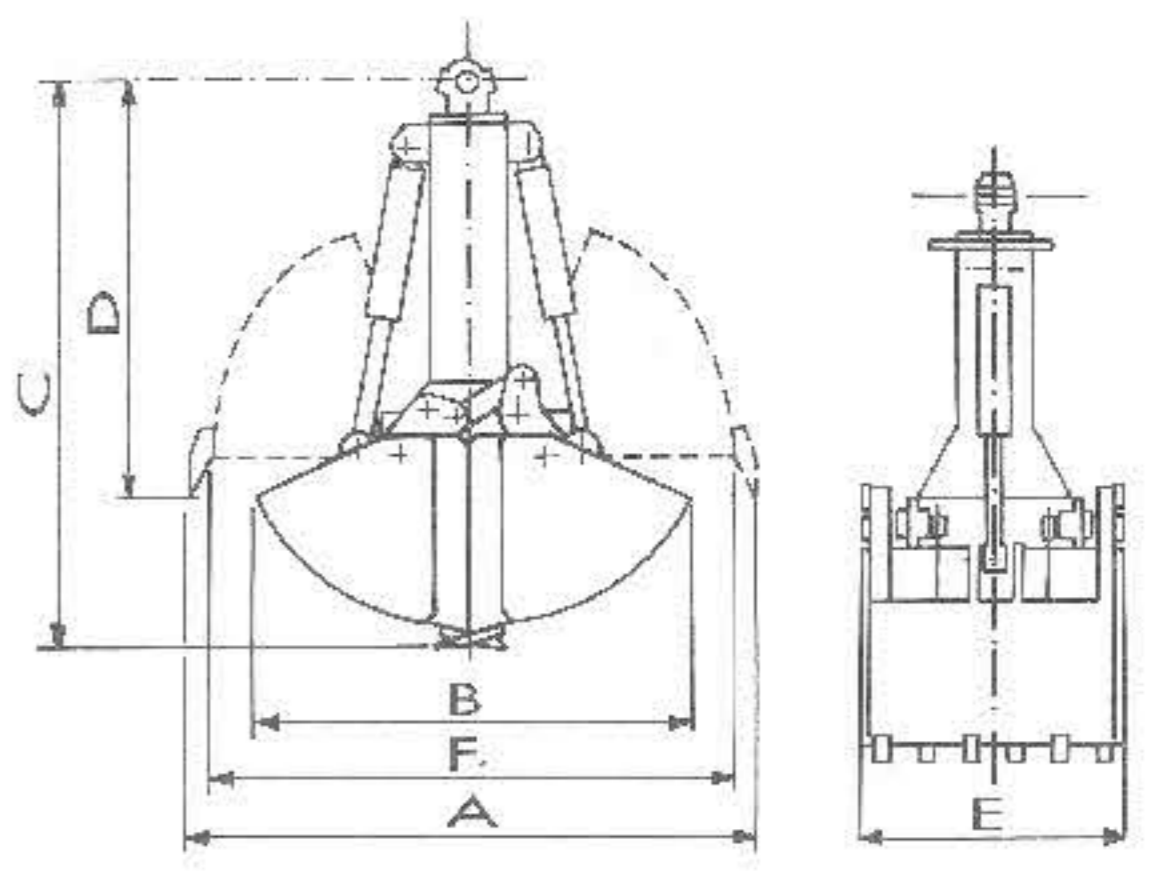

**GRAPPIN de terrassement
avec rotateur encastré
SÉRIE BMV**

**BENNA idrauliche
con rotatore incassato
SERIE BMV**

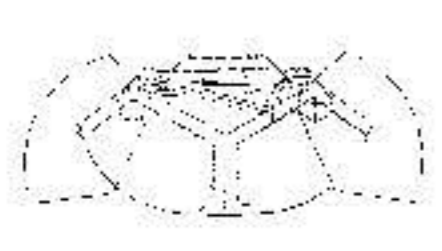

Edition 3-20

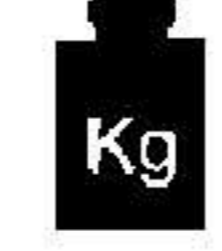
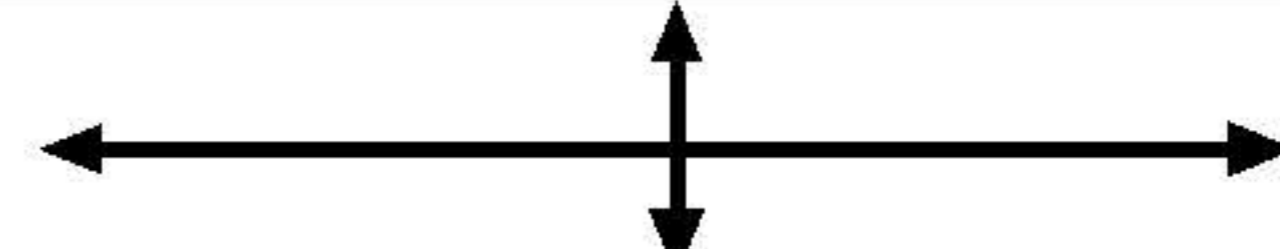
								
				A	B	C	D	E
BMV2 1000	1000	300	1500	2400	1950	2000	1400	1000
BMV2 1300	1350	300	1700	2400	1950	2000	1400	1300
BMV2 1500	1600	300	1900	2400	1950	2000	1400	1500
BMV2 2000	2000	300	2350	2400	2030	2270	1420	1500

ZUBEHÖR/ ACCESSOIRES: Grabzähne/Dentes, Rotatoren/Rotateurs